

CAMA GHOST 1600 X 2000

BED GHOST 1600 X 2000

ASQUAL

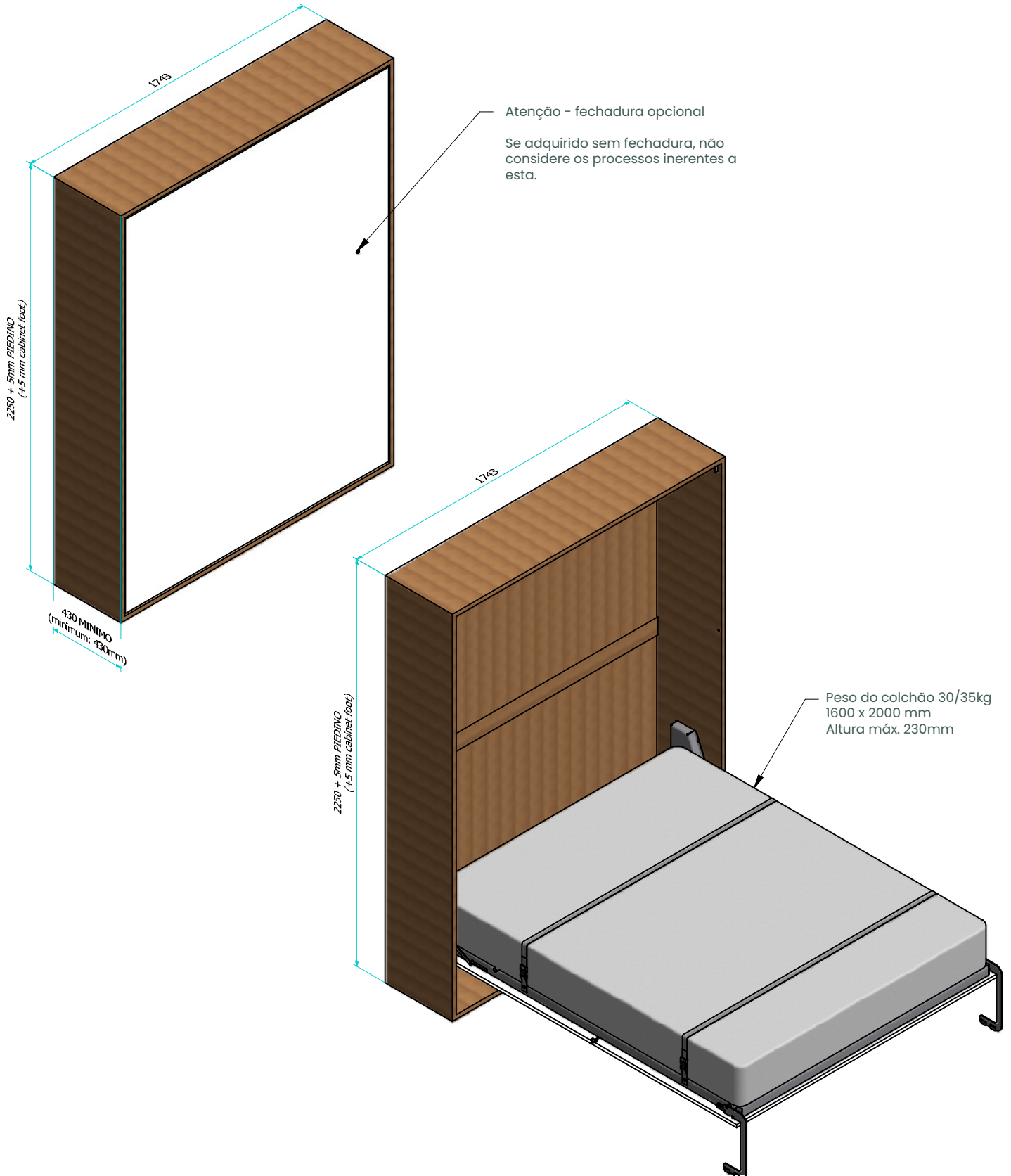

CAMA GHOST 1600 X 2000

BED GHOST 1600 X 2000



A-A (1:24)

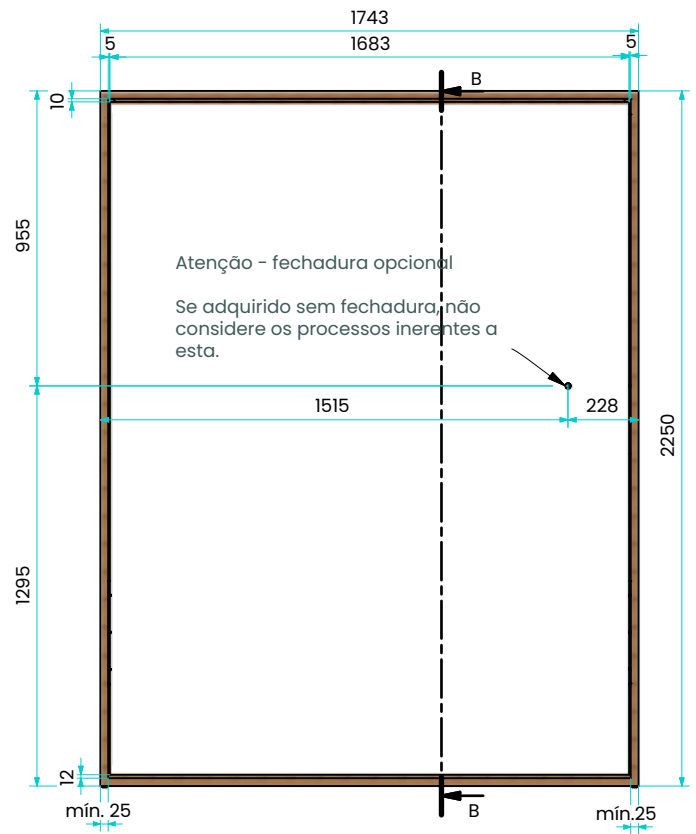
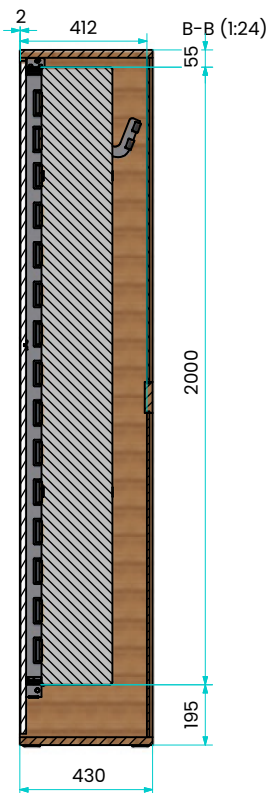
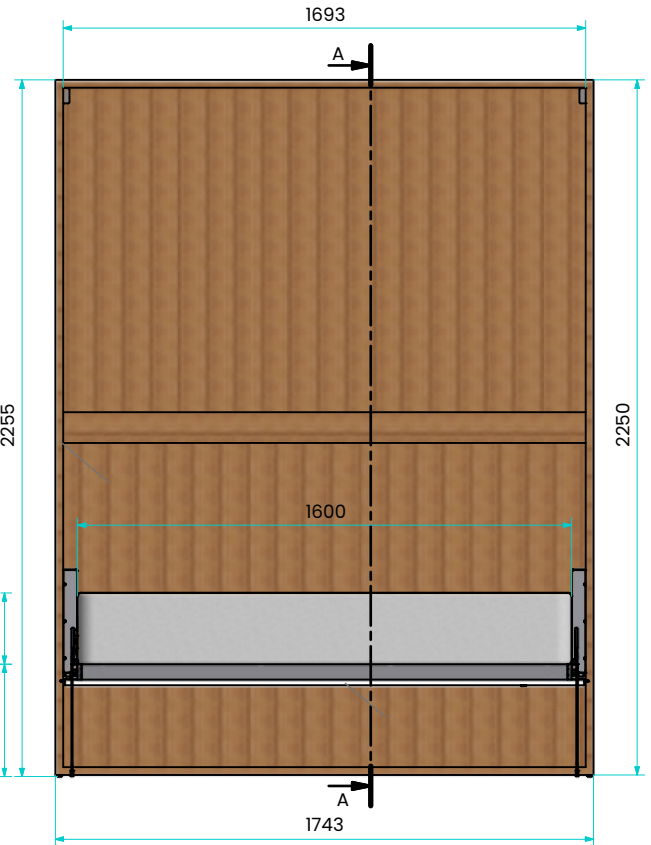
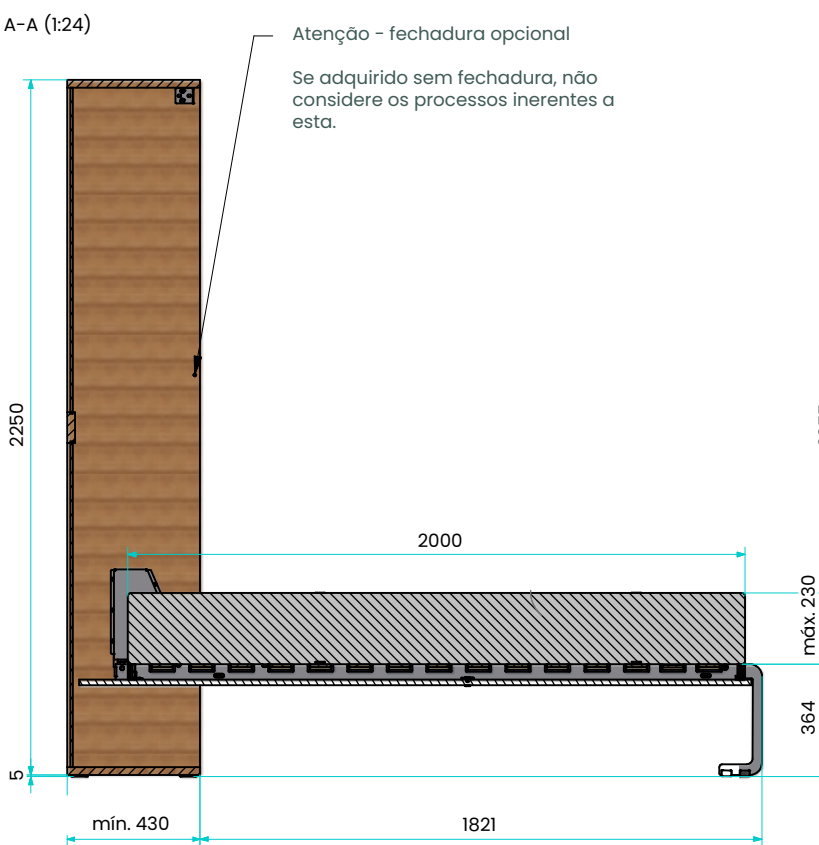

CAMA GHOST 1600 X 2000

BED GHOST 1600 X 2000



MÓVEL

Atenção - fechadura opcional
 Se adquirido sem fechadura, não considere os processos inerentes a esta.

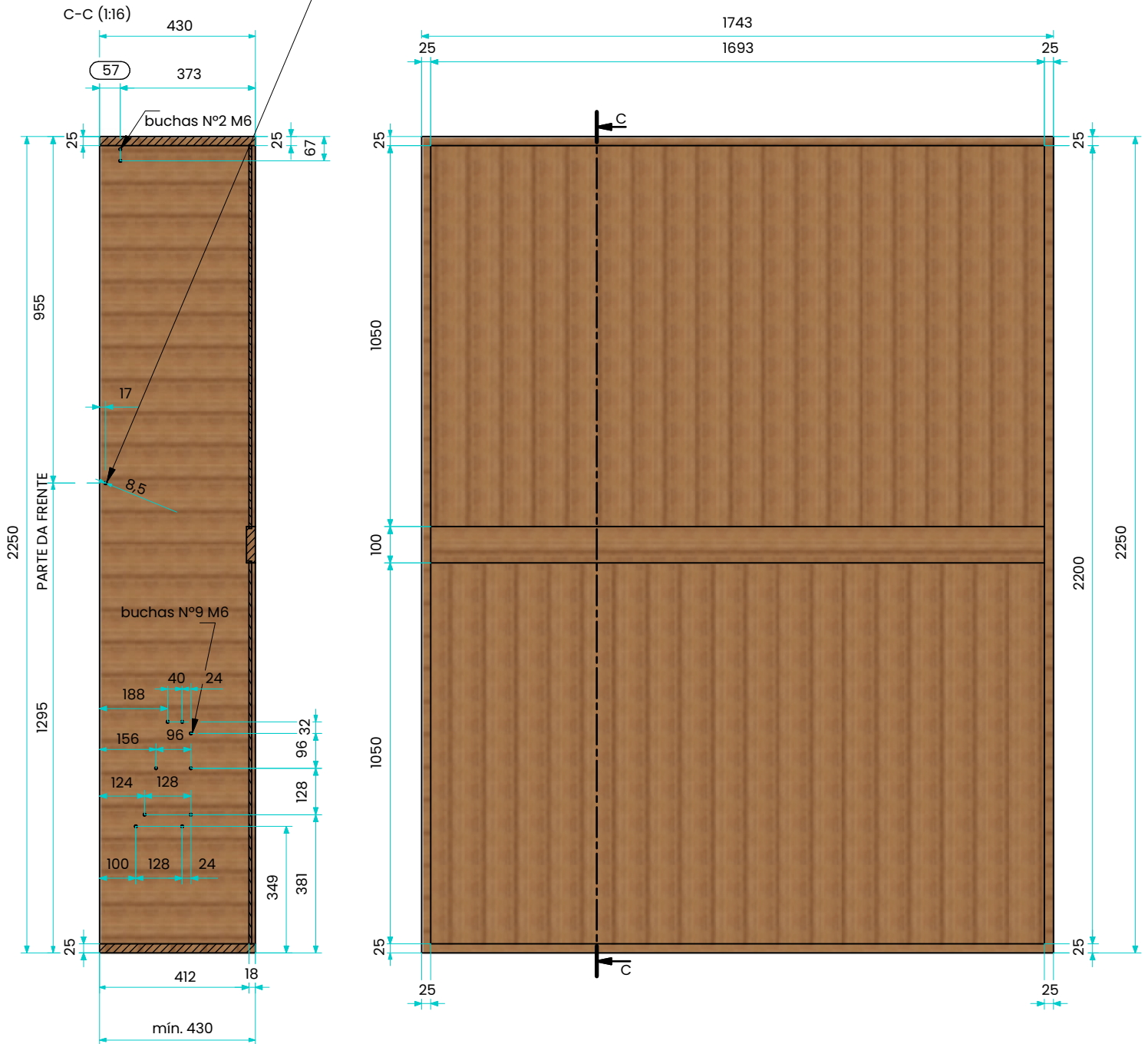

CAMA GHOST 1600 X 2000

BED GHOST 1600 X 2000



PONTOS DE FIXAÇÃO DO PAINEL FRONTAL
 PESO DO PAINEL 44kg +/- 4%

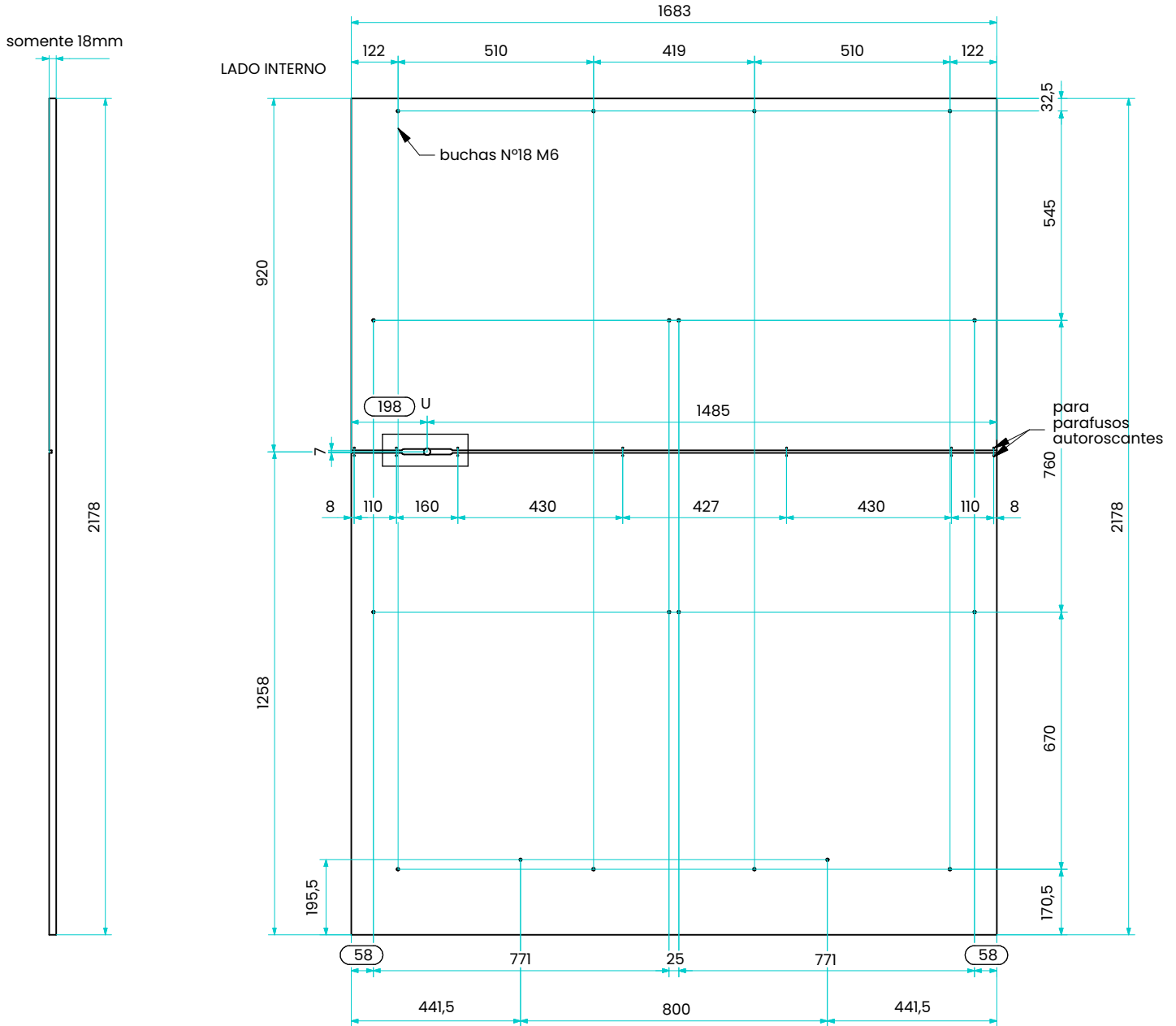

DETALHE

Verificar com a fechadura e haste

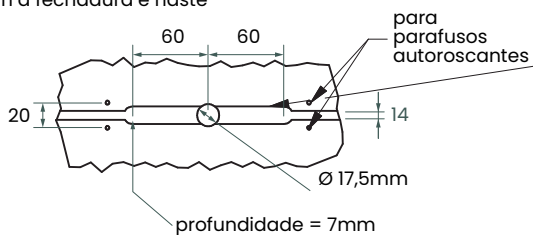

Atenção - fechadura opcional

Se adquirido sem fechadura, não considere os processos inerentes a esta.

CAMA GHOST 1600 X 2000

BED GHOST 1600 X 2000



FECHO (1ADSR040)

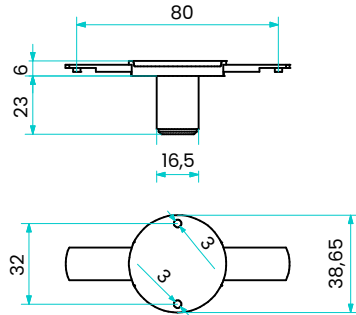

ESPAÇADOR DA FECHADURA (2ADSP039017002)

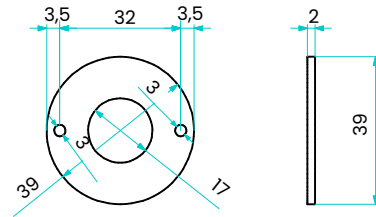

Atenção - fechadura opcional

Se adquirido sem fechadura, não considere os processos inerentes a esta última.

Nº 7 PLACA DE FIXAÇÃO (2ADSP030015002)

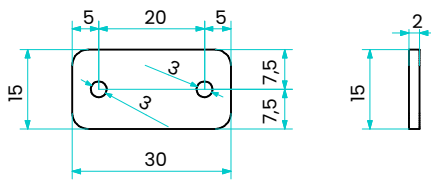

HASTE CURTA (2ADSR042)

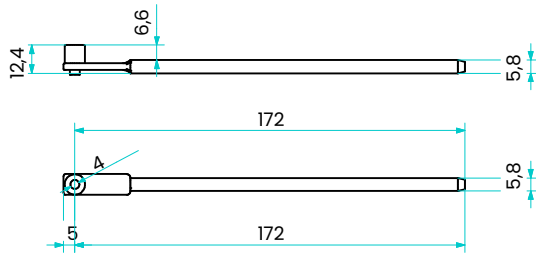

HASTE LONGA (2ADSR041)

